

ΚΟΙΝΟΧΡΗΣΤΟΙ

ΧΩΡΟΙ

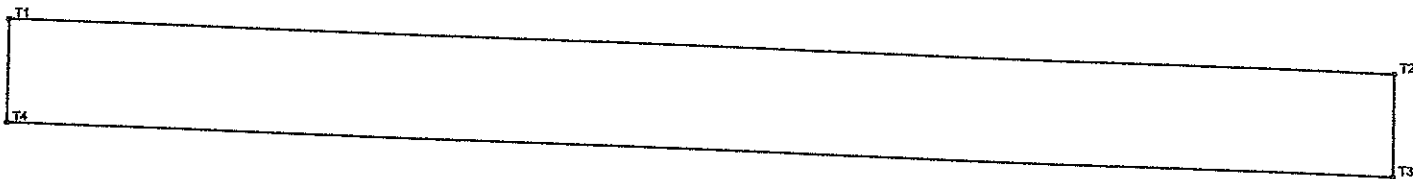

Κοινόχρηστος Χώρος							
id:2700A		Σημεία:5		Εμβαδό:479.25 m ²			
Σημείο	X	Y	μήκος	Σημείο	X	Y	μήκος
T1	477533.850	4218714.663	79.85	T4	477533.649	4218708.666	6.00
T2	477613.608	4218710.897		6.00	T1	477533.850	
T3	477613.465	4218704.897	79.91				

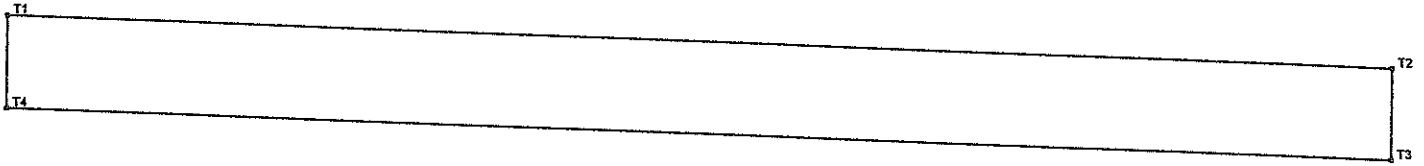

Κοινόχρηστος χώρος							
id:2702A				Σημεία:5		Εμβαδό:539.14 m ²	
Σημείο	X	Y	μήκος	Σημείο	X	Y	μήκος
T1	477619.603	4218710.614	90.02	T4	477619.460	4218704.614	6.00
T2	477709.527	4218706.371		5.98	T1	477619.603	
T3	477709.385	4218700.393	90.02				

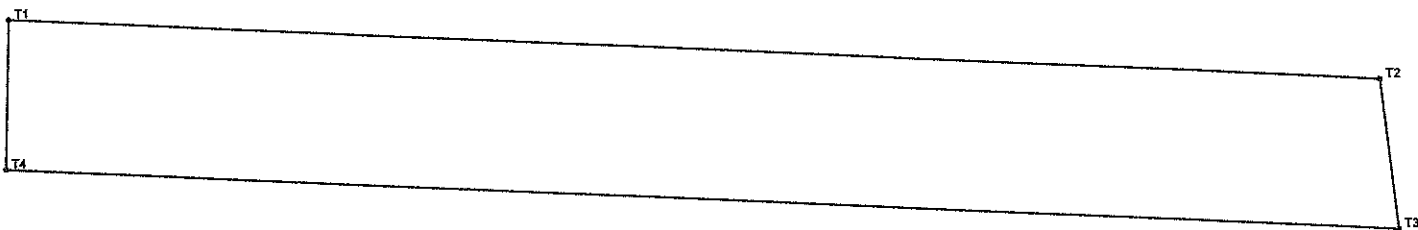

Κοινόχρηστος χώρος							
id:2703A				Σημεία: 5		Εμβαδό: 329.59 m ²	
Σημείο	X	Y	μήκος	Σημείο	X	Y	μήκος
T1	477715.522	4218706.075		T4	477715.380	4218700.086	
			54.59				5.99
T2	477770.044	4218703.281		T1	477715.522	4218706.075	
			6.08				
T3	477770.780	4218697.247					
			55.47				

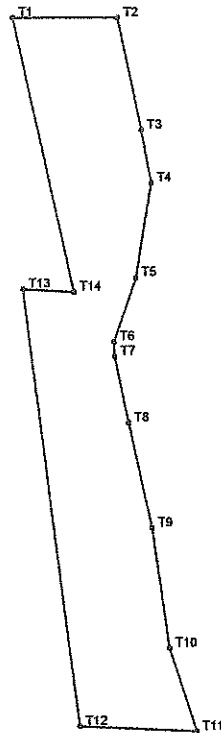

Κολνόχρηστος Χώρος							
id:2704		Σημεία:15		Εμβαδό:1903.56 m ²			
Σημείο	X	Y	μήκος	Σημείο	X	Y	μήκος
T1	477766.486	4218815.434	17.44	T9	477789.240	4218729.848	20.24
T2	477783.929	4218815.295	19.29	T10	477792.052	4218709.800	14.59
T3	477787.934	4218796.425	9.04	T11	477796.565	4218695.926	19.73
T4	477789.553	4218787.528	16.02	T12	477776.863	4218696.936	73.48
T5	477786.833	4218771.740	11.28	T13	477767.959	4218769.878	8.56
T6	477783.126	4218761.087	2.50	T14	477776.503	4218769.360	47.15
T7	477783.207	4218758.588	11.37	T1	477766.486	4218815.434	
T8	477785.459	4218747.445	18.00				

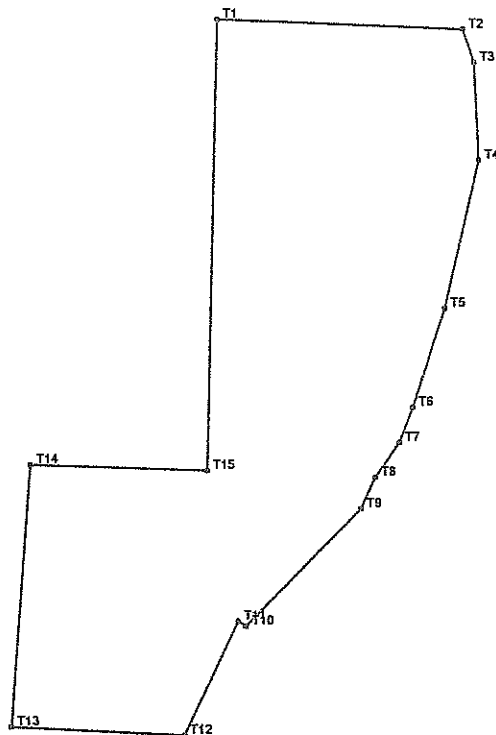

Κοινόχρηστος Χώρος							
id:2707		Σημεία:16		Εμβαδό:1257.61 m ²			
Σημείο	X	Y	μήκος	Σημείο	X	Y	μήκος
T1	477777.601	4218690.890	20.99	T9	477789.512	4218648.876	14.07
T2	477798.561	4218689.816		2.98	T10	477779.602	4218638.885
T3	477799.483	4218686.978	8.43	T11	477778.954	4218639.358	10.79
T4	477799.831	4218678.554	13.00	T12	477774.242	4218629.653	14.56
T5	477796.809	4218665.910	8.88	T13	477759.705	4218630.506	22.45
T6	477794.011	4218657.483	3.25	T14	477761.516	4218652.887	14.94
T7	477792.800	4218654.465	3.55	T15	477776.439	4218652.240	38.67
T8	477790.765	4218651.560	2.96	T1	477777.601	4218690.890	

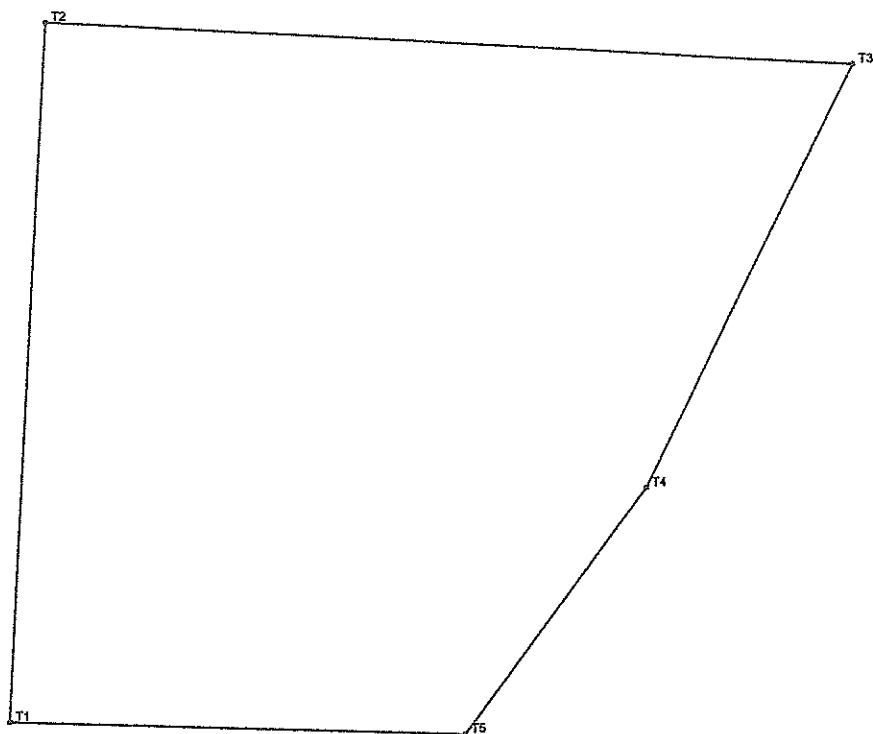

Κοινόχρηστος χώρος							
id:2712		Σημεία:6		Εμβαδό:724.31 m ²			
Σημείο	X	Y	μήκος	Σημείο	X	Y	μήκος
T1	477736.153	4218595.716	28.11	T4	477761.671	4218604.927	12.29
T2	477737.752	4218623.781		32.36	T5	477754.320	
T3	477770.053	4218621.885	18.92	T1	477736.153	4218595.716	

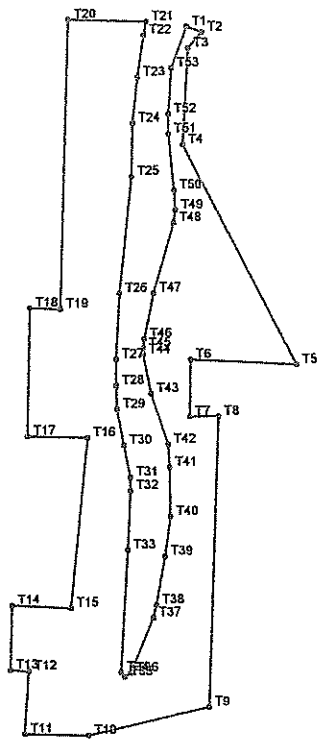

Κοινόχρηστος Χώρος							
id:2716		Σημεία:54		Εμβαδό:4612.09 m ²			
Σημείο	X	Y	μήκος	Σημείο	X	Y	μήκος
T1	477755.859	4218586.122		T28	477739.548	4218504.740	
			3.76				5.28
T2	477759.372	4218584.777		T29	477739.675	4218499.457	
			4.80				8.21
T3	477756.155	4218581.221		T30	477741.162	4218491.381	
			21.96				7.49
T4	477754.836	4218559.296		T31	477742.491	4218484.007	
			56.05				2.99
T5	477780.304	4218509.371		T32	477742.498	4218481.022	
			24.04				13.50
T6	477756.292	4218510.602		T33	477741.782	4218467.539	
			12.91				27.78
T7	477756.013	4218497.699		T34	477740.088	4218439.809	
			6.47				1.28
T8	477762.485	4218497.721		T35	477740.941	4218438.854	
			65.84				1.63
T9	477759.934	4218431.935		T36	477742.305	4218439.742	
			27.94				13.42
T10	477732.710	4218425.641		T37	477747.454	4218452.134	
			14.41				2.99
T11	477718.311	4218426.097		T38	477748.205	4218455.025	
			14.22				11.26
T12	477719.303	4218440.285		T39	477750.184	4218466.112	
			4.02				9.00
T13	477715.291	4218440.541		T40	477751.478	4218475.018	
			14.64				11.27
T14	477715.753	4218455.177		T41	477751.408	4218486.291	
			13.23				5.23
T15	477728.966	4218454.504		T42	477751.081	4218491.507	
			38.71				12.00
T16	477733.001	4218493.000		T43	477747.286	4218502.896	
			13.53				9.01
T17	477719.484	4218493.567		T44	477745.617	4218511.751	
			28.96				1.48
T18	477720.155	4218522.516		T45	477745.529	4218513.229	
			6.88				2.24
T19	477727.031	4218522.186		T46	477745.873	4218515.441	
			65.80				10.53

<<ΣΥΝΕΧΙΖΕΤΑΙ>>

Κοινόχρηστος χώρος							
id:2716		Σημεία:54		Εμβαδό:4612.09 m ²			
Σημείο	X	Y	μήκος	Σημείο	X	Y	μήκος
T20	477729.139	4218587.957	17.66	T47	477748.002	4218525.749	16.53
T21	477746.784	4218587.340		3.15	T48	477752.636	
T22	477746.103	4218584.260	9.65	T49	477753.183	4218544.576	4.44
T23	477744.755	4218574.704	10.49	T50	477752.878	4218549.002	12.78
T24	477743.534	4218564.286	12.11	T51	477751.635	4218561.721	4.50
T25	477743.225	4218552.182	26.59	T52	477751.724	4218566.224	10.48
T26	477740.395	4218525.739	15.04	T53	477752.406	4218576.684	10.05
T27	477739.501	4218510.725	5.99	T1	477755.859	4218586.122	

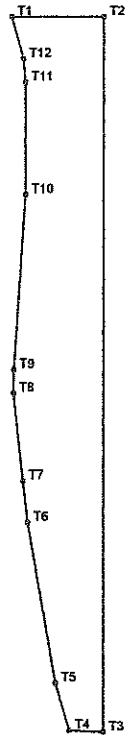

Κοινόχρηστος χώρος							
id:2723A		Σημεία:13		Εμβαδό:1304.92 m ²			
Σημείο	X	Y	μήκος	Σημείο	X	Y	μήκος
T1	477798.167	4218815.182	14.37	T8	477798.080	4218756.150	3.73
T2	477812.540	4218815.068		T9	477798.153	4218759.875	
T3	477811.652	4218703.145	111.93	T10	477800.192	4218787.244	27.45
T4	477806.432	4218703.419	5.23	T11	477800.268	4218804.820	17.58
T5	477804.281	4218710.844	7.73	T12	477799.966	4218808.543	3.74
T6	477800.165	4218736.008	25.50	T1	477798.167	4218815.182	6.88
T7	477799.529	4218742.522	6.54				
			13.70				

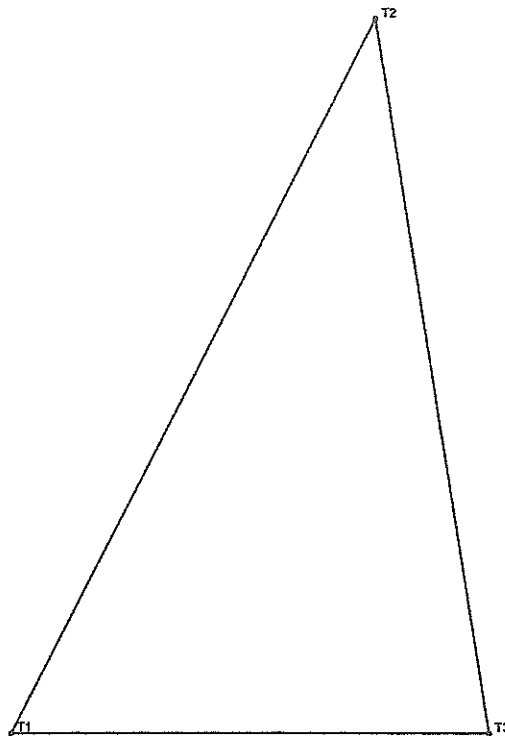

Κοινόχρηστος χώρος							
id:2729A		Σημεία:4		Εμβαδό:319.26 m ²			
Σημείο	X	Y	μήκος	Σημείο	X	Y	μήκος
T1	478182.810	4218694.941	34.70	T3	478203.415	4218694.741	20.61
T2	478198.737	4218725.775		31.38	T1	478182.810	

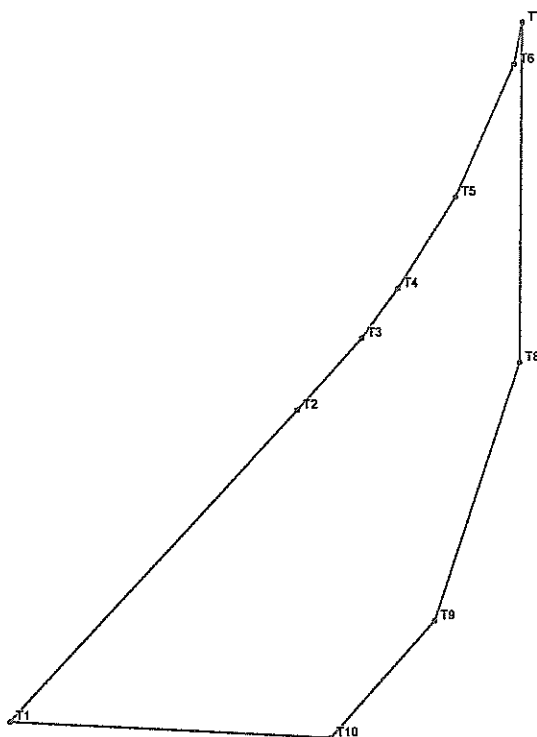

Κοινόχρηστος χώρος							
id:2732		Σημεία:11		Εμβαδό:484.86 m ²			
Σημείο	X	Y	μήκος	Σημείο	X	Y	μήκος
T1	477778.995	4218629.374	26.08	T7	477810.847	4218672.445	21.07
T2	477796.735	4218648.490		6.00	T8	477810.567	
T3	477800.775	4218652.923	3.79	T9	477805.165	4218635.405	9.69
T4	477803.029	4218655.971	6.70	T10	477798.665	4218628.219	19.70
T5	477806.654	4218661.605	9.01	T11	477778.995	4218629.374	
T6	477810.313	4218669.836	2.66				

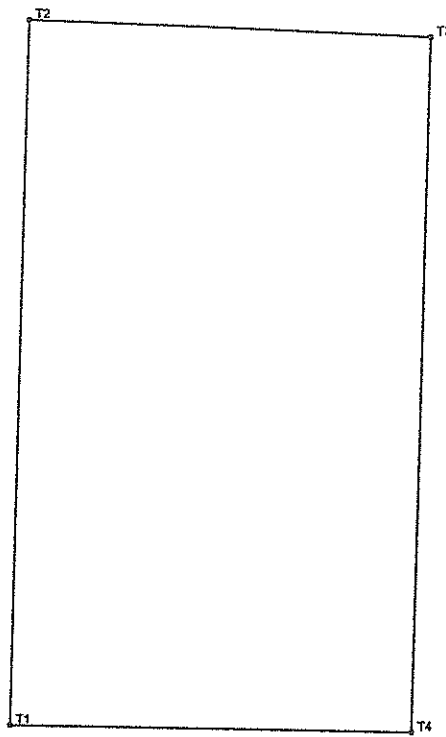

Κοινόχρηστος Χώρος							
id:2734				Σημεία:5		Εμβαδό:1096.59 m ²	
Σημείο	X	Y	μήκος	Σημείο	X	Y	μήκος
T1	477886.244	4218646.980	44.18	T4	477911.236	4218646.303	25.00
T2	477887.807	4218691.133		25.00	T1	477886.244	
T3	477912.776	4218689.822	43.55				

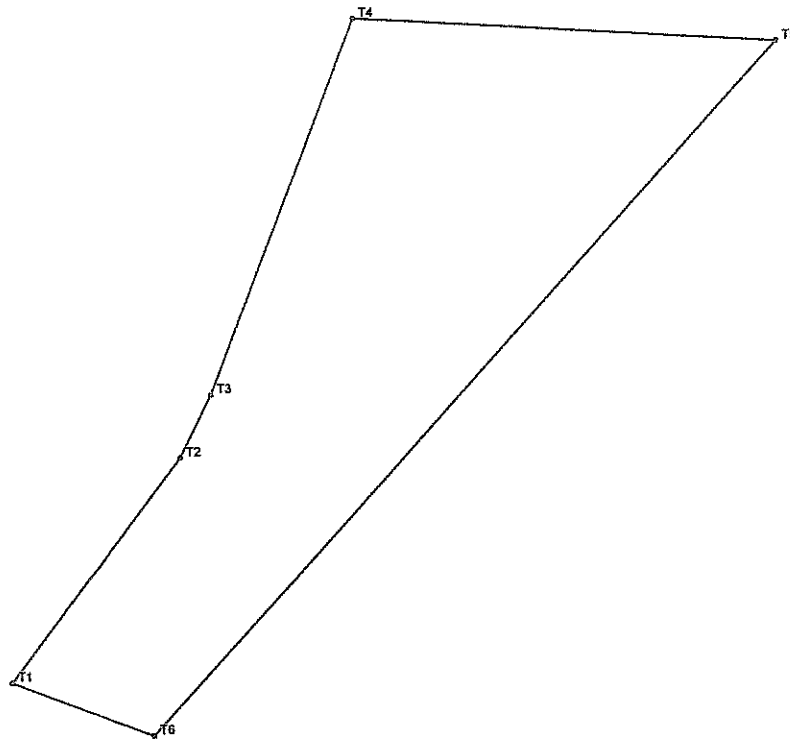

Κοινόχρηστος χώρος							
id:2740A			Σημεία:7		Εμβαδό:347.95 m ²		
Σημείο	X	Y	μήκος	Σημείο	X	Y	μήκος
T1	477759.131	4218593.436	11.94	T5	477791.782	4218620.609	39.74
T2	477766.304	4218602.982	2.98	T6	477765.127	4218591.140	6.42
T3	477767.609	4218605.659	17.13	T1	477759.131	4218593.436	
T4	477773.697	4218621.671	18.12				

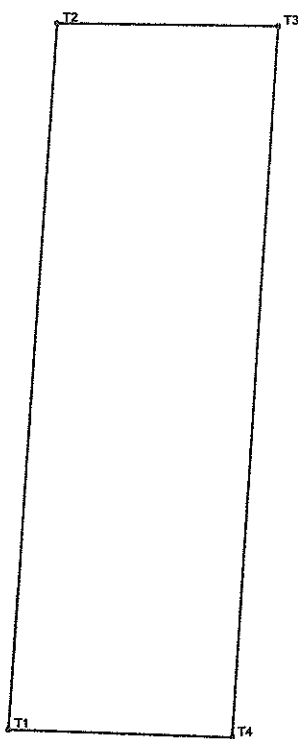

Κοινόχρηστος χώρος							
id:2741A				Σημεία:5		Εμβαδό:113.85 m ²	
Σημείο	X	Y	μήκος	Σημείο	X	Y	μήκος
T1	477901.152	4218599.925	19.06	T4	477907.121	4218599.644	5.98
T2	477902.593	4218618.926		5.94	T1	477901.152	
T3	477908.529	4218618.800	19.21				

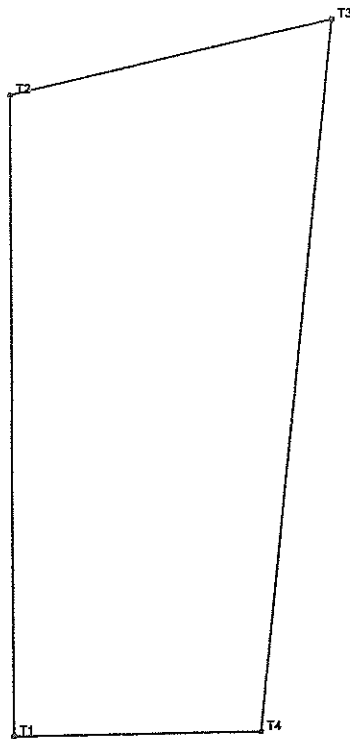

Κοινόχρηστος χώρος							
id:2762		Σημεία:5		Εμβαδό:521.14 m ²			
Σημείο	X	Y	μήκος	Σημείο	X	Y	μήκος
T1	477735.573	4218384.579	33.52	T4	477748.479	4218384.733	12.91
T2	477735.601	4218418.099		17.22	T1	477735.573	
T3	477752.376	4218421.977	37.45				

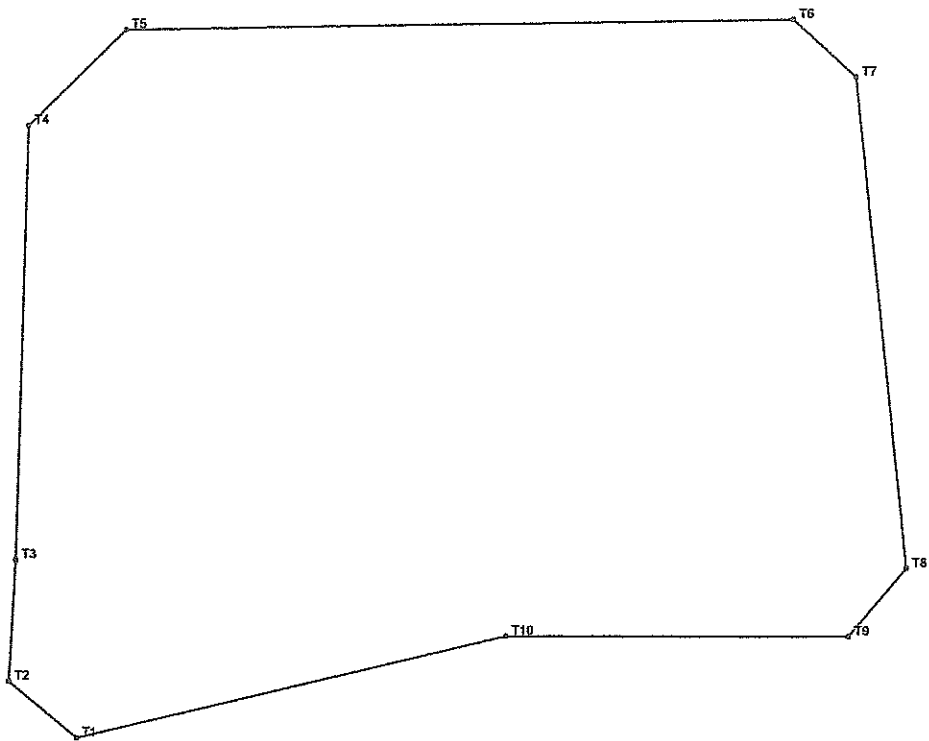

Κοινόχρηστος χώρος							
id:2769				Σημεία:11		Εμβαδό:2349.63 m ²	
Σημείο	X	Y	μήκος	Σημείο	X	Y	μήκος
T1	477738.145	4218330.100		T7	477789.567	4218373.322	
			5.78	T8	477792.654	4218340.943	32.52
T2	477733.736	4218333.845	8.01	T9	477788.890	4218336.503	5.82
T3	477734.257	4218341.843	28.55	T10	477766.282	4218336.611	22.61
T4	477735.225	4218370.375	8.97	T1	477738.145	4218330.100	28.88
T5	477741.641	4218376.651	43.83				
T6	477785.472	4218377.174	5.62				

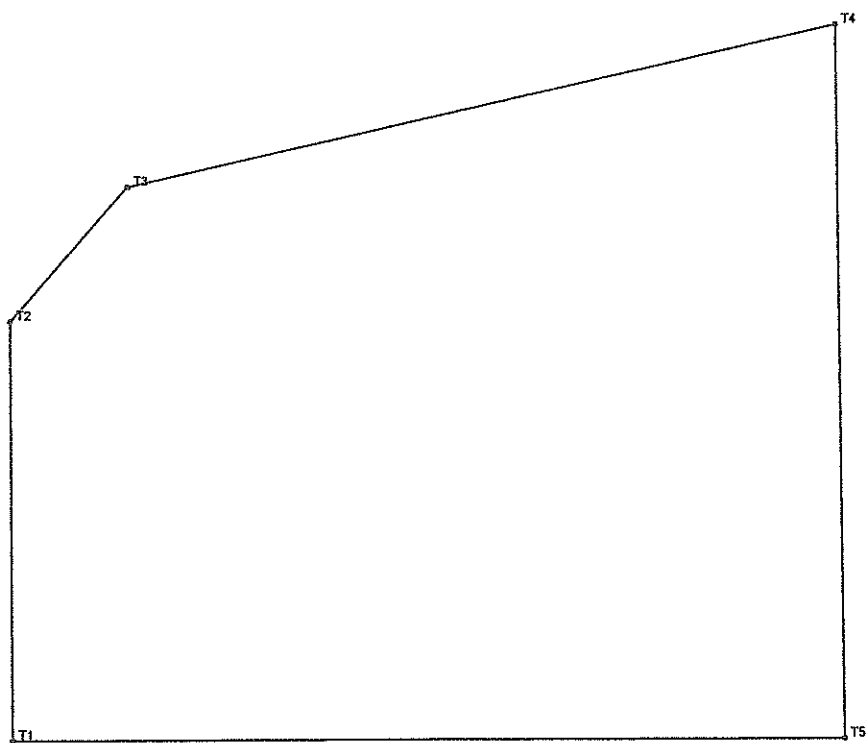

Κοινόχρηστος χώρος							
id:2774		Σημεία:6		Εμβαδό:892.86 m ²			
Σημείο	X	Y	μήκος	Σημείο	X	Y	μήκος
T1	477733.054	4218296.476	17.63	T4	477767.400	4218326.606	30.02
T2	477732.948	4218314.101		7.48	T5	477767.804	
T3	477737.840	4218319.765	30.34	T1	477733.054	4218296.476	

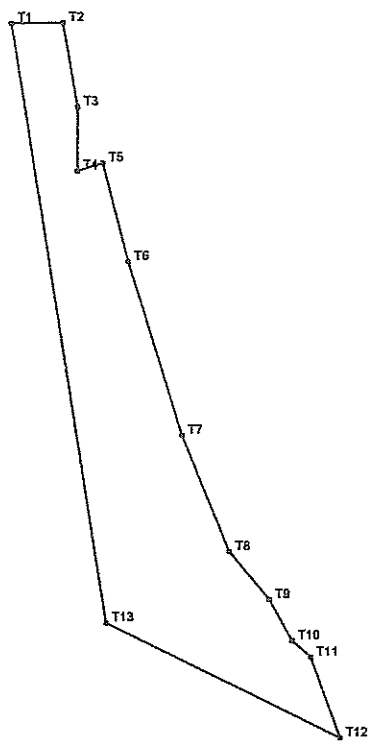

Κοινόχρηστος χώρος							
id:2814		Σημεία:14		Εμβαδό:1065.69 m ²			
Σημείο	X	Y	μήκος	Σημείο	X	Y	μήκος
T1	478214.750	4218686.630		T8	478242.007	4218619.005	
T2	478221.233	4218686.566	6.48	T9	478247.088	4218612.923	7.93
T3	478222.979	4218675.849	10.86	T10	478249.909	4218607.679	5.96
T4	478222.896	4218667.668	8.18	T11	478252.270	4218605.535	3.19
T5	478226.090	4218668.609	3.33	T12	478255.933	4218595.279	10.89
T6	478229.294	4218656.065	12.95	T13	478226.290	4218610.058	33.12
T7	478236.016	4218633.895	23.17	T1	478214.750	4218686.630	77.44
			16.05				

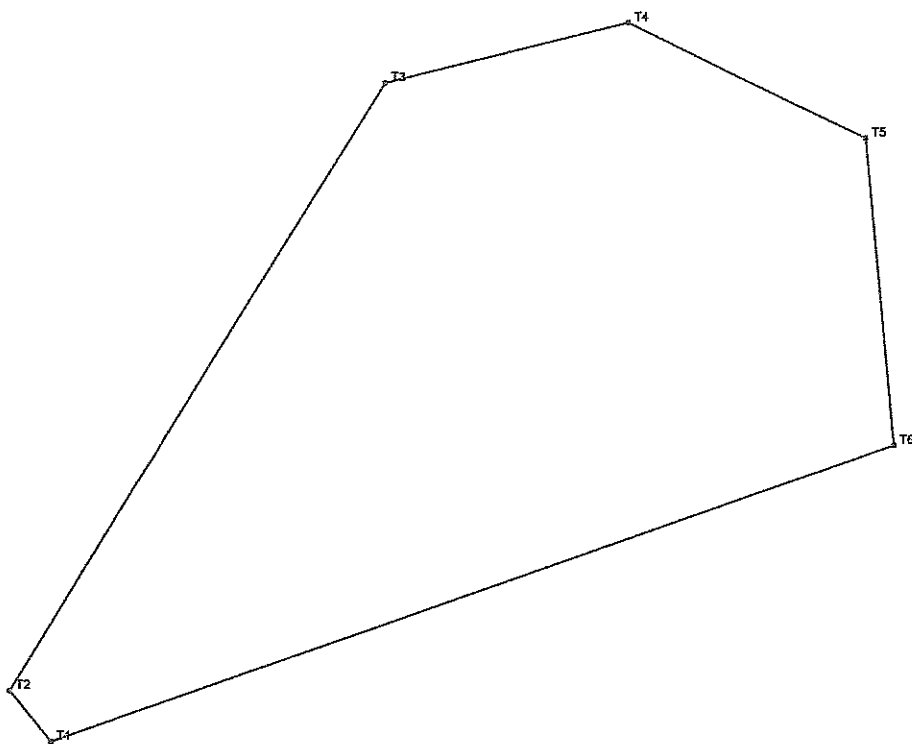

Κοινόχρηστος χώρος							
id:2815				Σημεία:7		Εμβαδό:636.48 m ²	
Σημείο	X	Y	μήκος	Σημείο	X	Y	μήκος
T1	478221.453	4218558.090	2.83	T5	478256.501	4218583.822	13.28
T2	478219.682	4218560.291	30.65	T6	478257.626	4218570.590	38.27
T3	478235.850	4218586.327	10.78	T1	478221.453	4218558.090	
T4	478246.316	4218588.900	11.38				

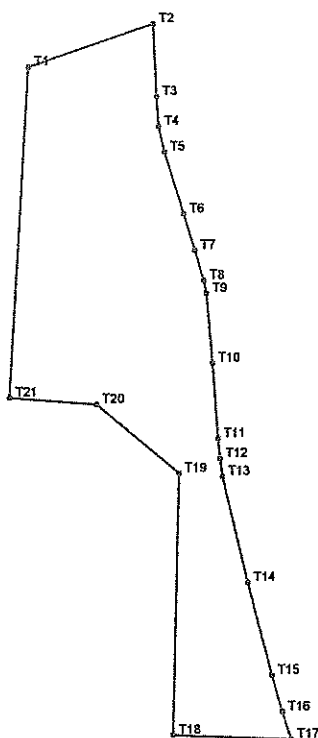

Κοινόχρηστος χώρος							
id:2817		Σημεία:22		Εμβαδό:1185.10 m ²			
Σημείο	X	Y	μήκος	Σημείο	X	Y	μήκος
T1	478247.198	4218556.406	15.47	T12	478269.484	4218510.187	2.17
T2	478261.817	4218561.457		T13	478269.843	4218508.045	
T3	478262.163	4218552.820	8.64	T14	478272.777	4218495.558	12.83
T4	478262.394	4218549.310	3.52	T15	478275.531	4218484.650	11.25
T5	478263.142	4218546.269	3.13	T16	478276.718	4218480.310	4.50
T6	478265.336	4218538.994	7.60	T17	478277.766	4218477.101	3.38
T7	478266.649	4218534.690	4.50	T18	478263.828	4218477.624	13.95
T8	478267.677	4218531.162	3.67	T19	478264.657	4218508.411	30.80
T9	478268.039	4218529.629	1.58	T20	478255.079	4218516.613	12.61
T10	478268.710	4218521.409	8.25	T21	478244.864	4218517.420	10.25
T11	478269.281	4218512.505	8.92	T1	478247.198	4218556.406	39.06
			2.33				

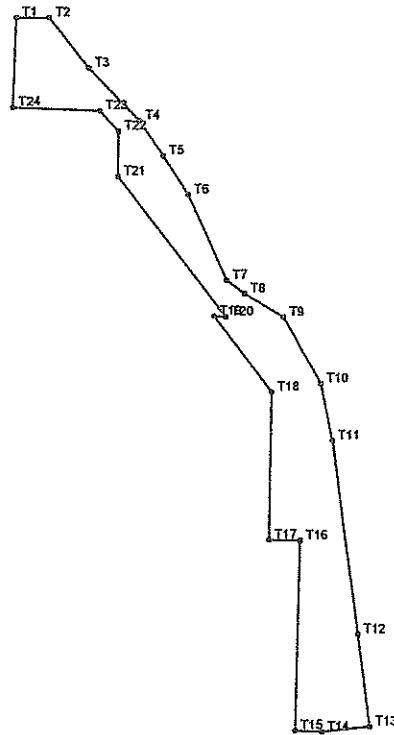

Κοινόχρηστος Χώρος							
id:2820		Σημεία:25		Εμβαδό:2055.00 m ²			
Σημείο	X	Y	μήκος	Σημείο	X	Y	μήκος
T1	478274.488	4218471.220	7.28	T14	478342.277	4218310.929	5.94
T2	478281.767	4218470.946		14.25	T15	478336.341	
T3	478290.433	4218459.630	16.41	T16	478337.635	4218353.686	7.05
T4	478301.800	4218447.800		9.56	T17	478330.586	
T5	478307.137	4218439.864	10.25	T18	478331.320	4218386.998	21.31
T6	478312.608	4218431.201		21.07	T19	478318.371	
T7	478321.299	4218412.009	4.98	T20	478320.967	4218403.824	39.66
T8	478325.314	4218409.070		10.22	T21	478296.874	
T9	478333.997	4218403.687	17.01	T22	478297.081	4218445.473	6.19
T10	478342.309	4218388.845		13.02	T23	478292.961	
T11	478344.819	4218376.065	43.74	T24	478273.517	4218451.011	20.23
T12	478350.401	4218332.679		20.73	T1	478274.488	
T13	478353.047	4218312.119	10.84				

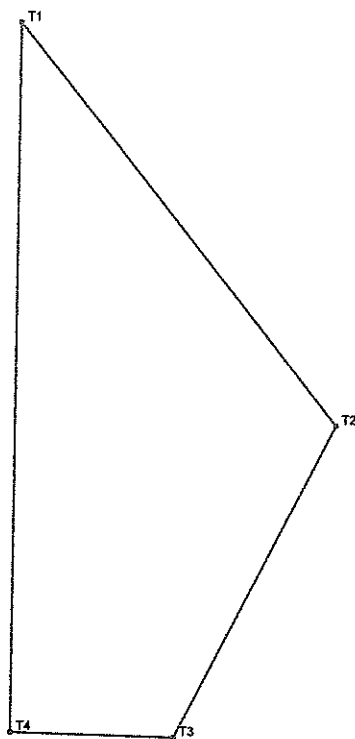

Κοινόχρηστος χώρος							
id:2822A				Σημεία:5		Εμβαδό:58.84 m ²	
Σημείο	X	Y	μήκος	Σημείο	X	Y	μήκος
T1	478292.716	4218427.591	10.52	T4	478292.418	4218412.970	14.62
T2	478299.110	4218419.232		7.23	T1	478292.716	
T3	478295.741	4218412.837	3.33				

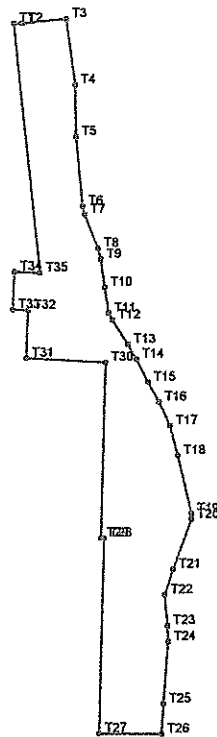

Κοινόχρηστος χώρος							
id:2830		Σημεία:36		Εμβαδό:3269.02 m ²			
Σημείο	X	Y	μήκος	Σημείο	X	Y	μήκος
T1	478340.493	4218301.000		T19	478386.857	4218171.124	
T2	478342.597	4218300.904	2.11	T20	478386.929	4218169.467	1.66
T3	478354.329	4218302.200	11.80	T21	478381.959	4218156.290	14.08
T4	478356.625	4218284.583	17.77	T22	478379.864	4218149.563	7.05
T5	478356.889	4218270.813	13.77	T23	478380.451	4218141.418	8.17
T6	478358.463	4218252.359	18.52	T24	478380.616	4218137.224	4.20
T7	478359.018	4218250.184	2.24	T25	478379.350	4218120.768	16.50
T8	478362.516	4218241.248	9.60	T26	478378.825	4218112.876	7.91
T9	478363.301	4218238.368	2.99	T27	478362.422	4218113.043	16.40
T10	478364.226	4218230.893	7.53	T28	478363.889	4218164.589	51.57
T11	478365.229	4218224.233	6.74	T29	478363.106	4218164.628	0.78
T12	478366.267	4218222.267	2.22	T30	478364.430	4218211.106	46.50
T13	478370.368	4218215.797	7.66	T31	478343.487	4218212.247	20.97
T14	478372.560	4218212.027	4.36	T32	478343.973	4218225.021	12.78
T15	478375.587	4218205.865	6.87	T33	478339.977	4218225.208	4.00
T16	478378.388	4218200.675	5.90	T34	478340.354	4218235.108	9.91
T17	478381.400	4218194.386	6.97	T35	478347.116	4218234.790	6.77
T18	478383.449	4218186.500	8.15	T1	478340.493	4218301.000	66.54
			15.75				

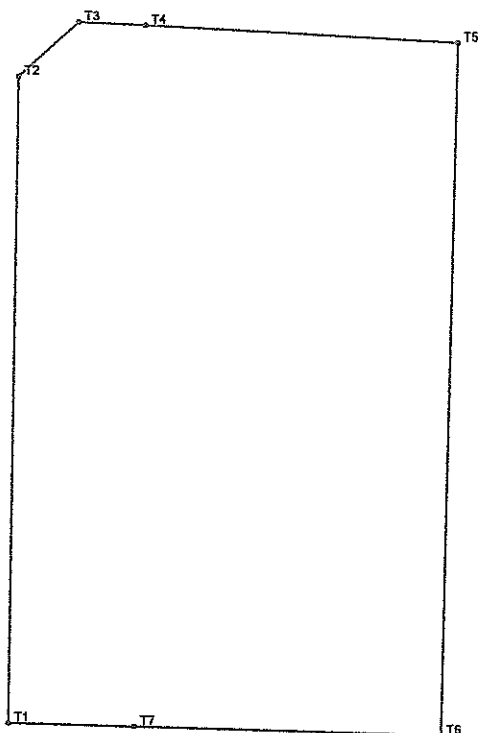

Κοινόχρηστος χώρος							
id:2833		Σημεία:8		Εμβαδό:1252.89 m ²			
Σημείο	X	Y	μήκος	Σημείο	X	Y	μήκος
T1	478164.525	4218208.329	41.70	T5	478193.594	4218252.060	44.75
T2	478165.406	4218250.018		5.23	T6	478192.230	
T3	478169.252	4218253.558	4.23	T7	478172.521	4218208.041	8.00
T4	478173.477	4218253.298	20.15	T1	478164.525	4218208.329	

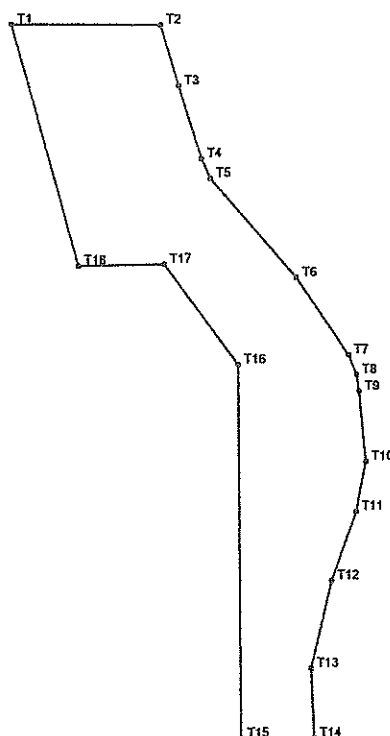

Κοινόχρηστος Χώρος							
id:2847			Σημεία:19		Εμβαδό:1655.64 m ²		
Σημείο	X	Y	μήκος	Σημείο	X	Y	μήκος
T1	478359.608	4218105.071	20.31	T11	478406.376	4218037.888	10.07
T2	478379.912	4218104.865	8.78	T12	478403.014	4218028.396	12.38
T3	478382.338	4218096.423	10.50	T13	478400.057	4218016.376	9.57
T4	478385.416	4218086.388	2.95	T14	478400.442	4218006.816	9.96
T5	478386.654	4218083.715	18.04	T15	478390.485	4218006.808	51.29
T6	478398.360	4218069.992	12.76	T16	478390.344	4218058.098	17.11
T7	478405.454	4218059.381	2.96	T17	478380.276	4218071.936	11.72
T8	478406.609	4218056.654	2.25	T18	478368.559	4218071.784	34.47
T9	478406.908	4218054.424	9.75	T1	478359.608	4218105.071	
T10	478407.757	4218044.712	6.96				



Κοινόχρηστος Χώρος							
id:2854		Σημεία:8		Εμβαδό:2819.25 m ²			
Σημείο	X	Y	μήκος	Σημείο	X	Y	μήκος
T1	478256.370	4218789.318	27.73	T5	478343.883	4218834.826	28.69
T2	478269.025	4218813.997	11.07	T6	478372.559	4218835.625	42.63
T3	478279.595	4218810.698	64.75	T7	478373.249	4218793.001	116.94
T4	478344.308	4218808.578	26.25	T1	478256.370	4218789.318	

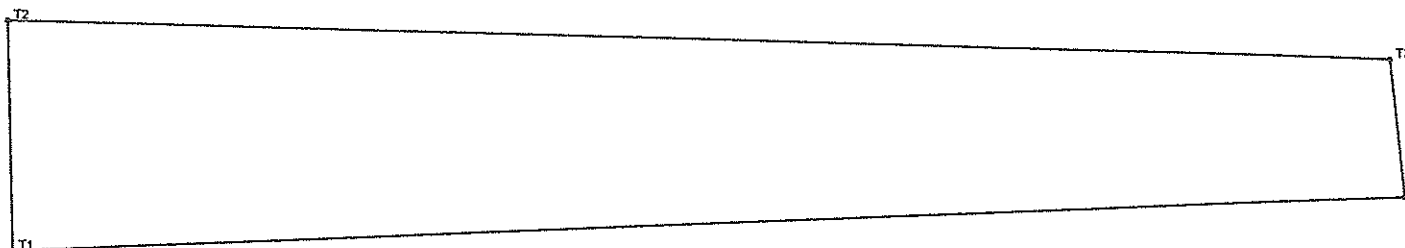

Κοινόχρηστος χώρος							
id:2856				Σημεία:5		Εμβαδό:732.95 m ²	
Σημείο	X	Y	μήκος	Σημείο	X	Y	μήκος
T1	478379.262	4218792.255	12.38	T4	478453.507	4218794.771	74.29
T2	478379.062	4218804.629		T1	478379.262	4218792.255	
T3	478452.748	4218802.215	73.73				
			7.48				

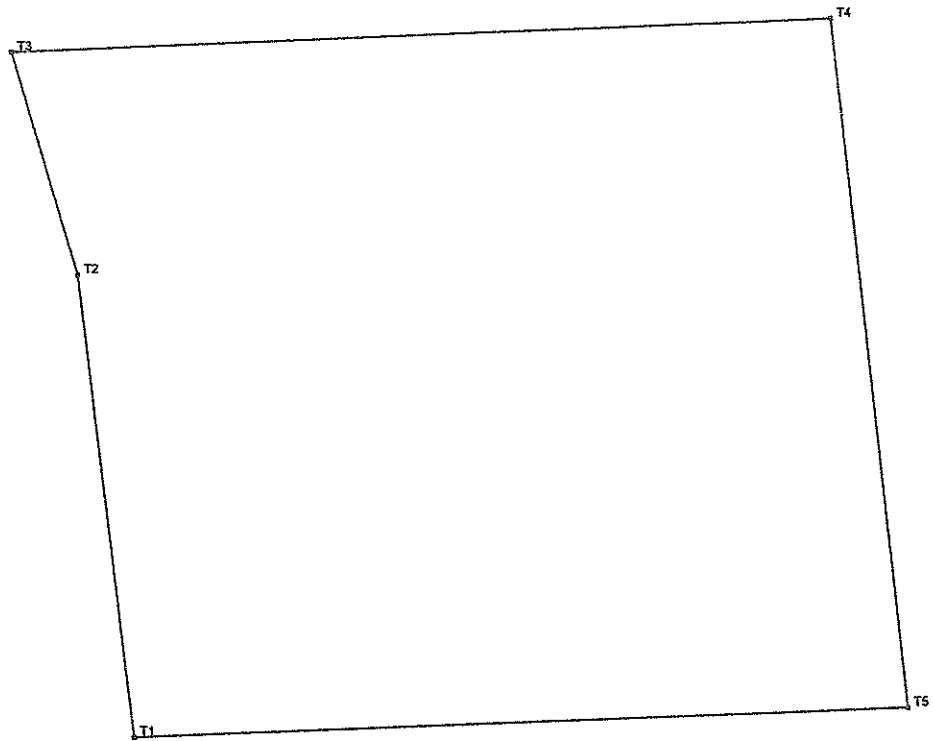

Κοινόχρηστος χώρος							
id:2880		Σημεία:6		Εμβαδό:1994.30 m ²			
Σημείο	X	Y	μήκος	Σημείο	X	Y	μήκος
T1	478426.378	4218235.171	28.31	T4	478468.660	4218278.776	42.30
T2	478423.081	4218263.285		14.19	T5	478473.138	
T3	478419.105	4218276.906	49.59	T1	478426.378	4218235.171	

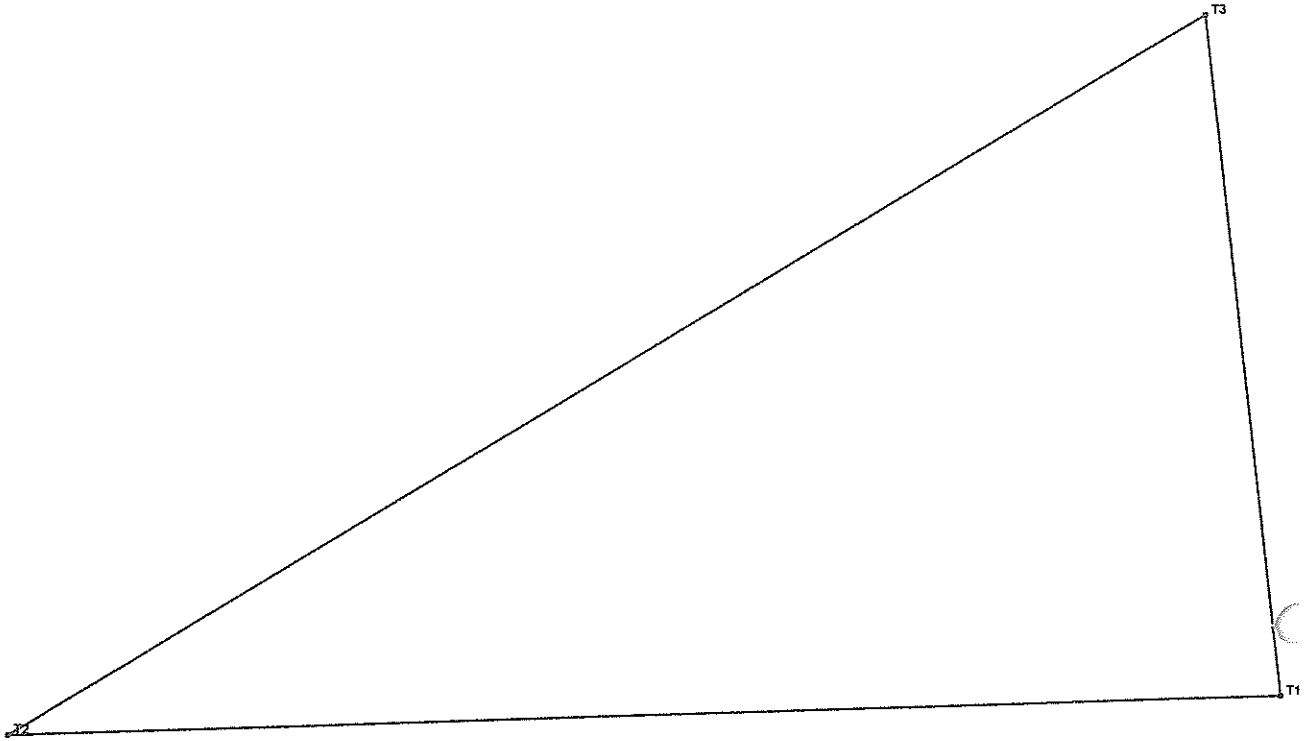

Κοινόχρηστος χώρος							
id:2886		Σημεία:4		Εμβαδό:2064.06 m ²			
Σημείο	X	Y	μήκος	Σημείο	X	Y	μήκος
T1	478541.208	4217993.669	87.45	T3	478536.194	4218040.759	47.36
T2	478453.787	4217991.388	96.06	T1	478541.208	4217993.669	

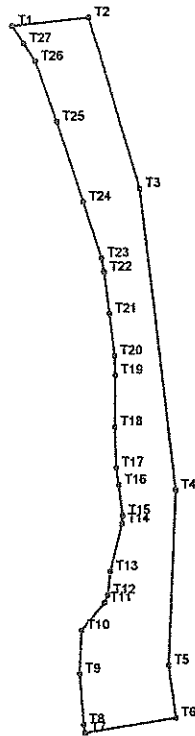

Κοινόχρηστος Χώρος							
id:2889		Σημεία:28		Εμβαδό:3086.14 m ²			
Σημείο	X	Y	μήκος	Σημείο	X	Y	μήκος
T1	478379.418	4218304.973	20.54	T15	478408.500	4218173.981	8.26
T2	478399.836	4218307.230	47.86	T16	478407.487	4218182.174	4.51
T3	478413.246	4218261.288	81.11	T17	478406.902	4218186.645	10.97
T4	478422.695	4218180.730	46.87	T18	478406.532	4218197.605	13.81
T5	478420.713	4218133.903	14.06	T19	478406.571	4218211.419	5.26
T6	478422.560	4218119.960	24.65	T20	478406.455	4218216.676	11.24
T7	478398.226	4218116.018	2.23	T21	478405.188	4218227.846	11.25
T8	478397.981	4218118.237	13.51	T22	478403.774	4218239.011	3.75
T9	478396.946	4218131.707	11.57	T23	478403.012	4218242.684	15.75
T10	478397.494	4218143.262	9.57	T24	478398.335	4218257.722	22.50
T11	478403.632	4218150.609	2.18	T25	478391.355	4218279.112	17.25
T12	478404.378	4218152.658	6.38	T26	478385.634	4218295.386	5.63
T13	478405.130	4218158.992	13.16	T27	478382.518	4218300.071	5.80
T14	478408.282	4218171.766	2.23	T1	478379.418	4218304.973	

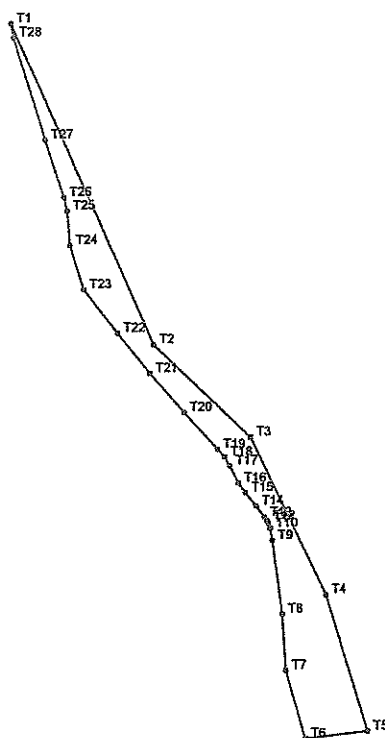

Κοινόχρηστος χώρος							
id:2890		Σημεία:29		Εμβαδό:3209.01 m ²			
Σημείο	X	Y	μήκος	Σημείο	X	Y	μήκος
T1	478270.196	4218574.167	127.19	T16	478351.182	4218407.023	6.99
T2	478320.761	4218457.460		48.51	T17	478348.050	
T3	478355.571	4218423.679	63.29	T18	478346.237	4218416.537	3.74
T4	478382.558	4218366.427	51.51	T19	478343.821	4218419.389	18.02
T5	478396.992	4218316.977	22.57	T20	478331.715	4218432.736	18.76
T6	478374.556	4218314.497	25.57	T21	478319.441	4218446.921	18.75
T7	478367.827	4218339.170	20.31	T22	478307.758	4218461.586	19.85
T8	478366.769	4218359.452	27.00	T23	478295.701	4218477.360	16.66
T9	478363.330	4218386.232	4.53	T24	478290.900	4218493.314	12.69
T10	478362.499	4218390.685	1.91	T25	478289.947	4218505.973	4.85
T11	478361.872	4218392.488	1.01	T26	478288.747	4218510.671	21.80
T12	478361.349	4218393.357	1.54	T27	478282.308	4218531.499	39.00
T13	478360.461	4218394.618	5.21	T28	478271.123	4218568.859	5.39
T14	478357.323	4218398.773	6.02	T1	478270.196	4218574.167	
T15	478353.662	4218403.557	4.26				

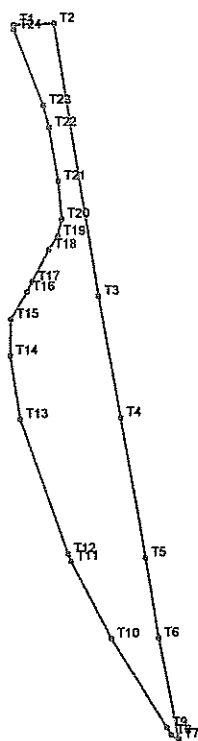

Κοινόχρηστος Χώρος							
id:2891				Σημεία:25		Εμβαδό:2696.45 m ²	
Σημείο	X	Y	μήκος	Σημείο	X	Y	μήκος
T1	478227.448	4218773.711		T14	478226.289	4218688.099	
T2	478237.717	4218774.129	10.28	T15	478226.339	4218697.469	9.37
T3	478248.922	4218703.522	71.49	T16	478230.527	4218704.578	8.25
T4	478254.429	4218671.997	32.00	T17	478231.794	4218707.181	2.90
T5	478260.713	4218635.774	36.76	T18	478236.102	4218715.573	9.43
T6	478264.111	4218615.263	20.79	T19	478238.382	4218719.047	4.16
T7	478269.230	4218589.069	26.69	T20	478239.397	4218723.449	4.52
T8	478267.214	4218590.011	2.23	T21	478238.647	4218733.183	9.76
T9	478266.123	4218592.112	2.37	T22	478236.301	4218747.027	14.04
T10	478251.776	4218614.950	26.97	T23	478234.879	4218752.882	6.03
T11	478241.547	4218634.972	22.48	T24	478227.457	4218772.434	20.91
T12	478240.714	4218637.057	2.25	T1	478227.448	4218773.711	1.28
T13	478228.638	4218671.776	36.76				
			16.49				

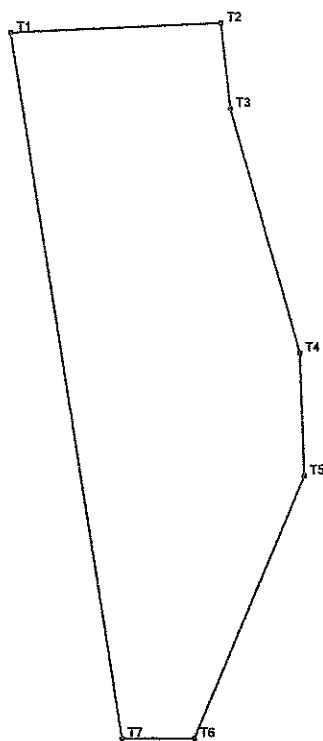

Κοινόχρηστος Χώρος							
id:2892		Σημεία:8		Εμβαδό:1683.54 m ²			
Σημείο	X	Y	μήκος	Σημείο	X	Y	μήκος
T1	478201.784	4218772.665	23.05	T5	478233.791	4218723.503	31.44
T2	478224.816	4218773.603		9.57	T6	478221.496	
T3	478225.785	4218764.087	28.05	T7	478213.542	4218694.642	78.90
T4	478233.361	4218737.081	13.58	T1	478201.784	4218772.665	

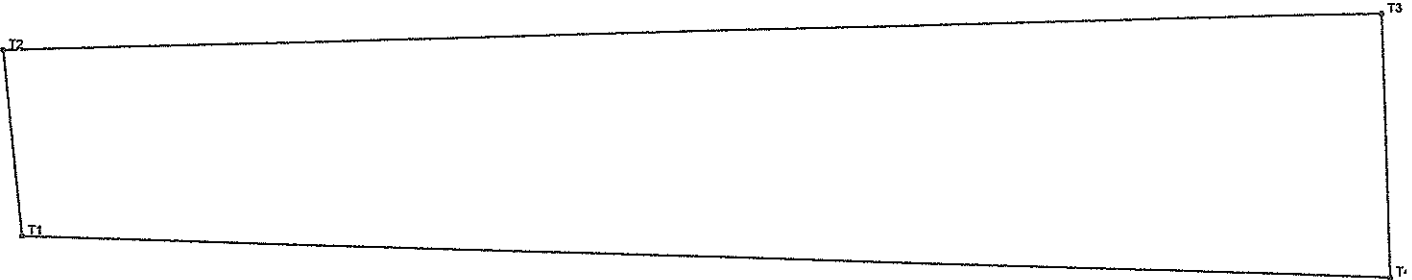

Κοινόχρηστος Χώρος							
id:2898				Σημεία:5		Εμβαδό:315.65 m ²	
Σημείο	X	Y	μήκος	Σημείο	X	Y	μήκος
T1	478467.108	4218799.398	5.99	T4	478510.718	4218797.963	43.63
T2	478466.501	4218805.353		43.98	T1	478467.108	
T3	478510.464	4218806.429	8.47				

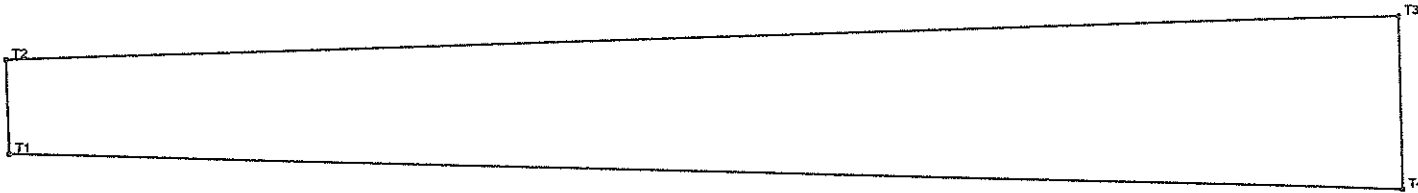

Κοινόχρηστος χώρος							
id:2899				Σημεία:5		Εμβαδό:1601.62 m ²	
Σημείο	X	Y	μήκος	Σημείο	X	Y	μήκος
T1	478515.725	4218797.799	8.76	T4	478644.464	4218793.562	128.81
T2	478515.463	4218806.552		T1	478515.725	4218797.799	
T3	478644.122	4218809.701	128.70				
			16.14				

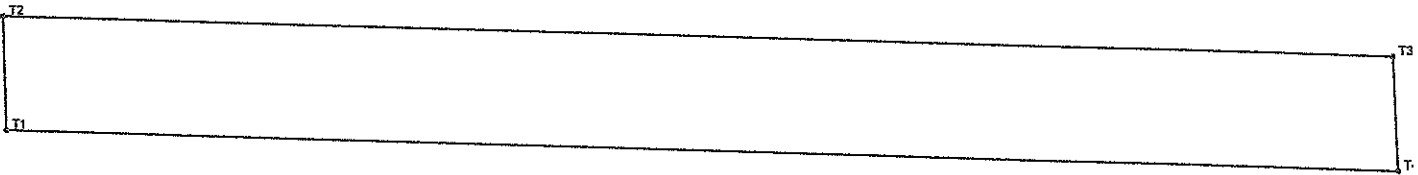

Κοινόχρηστος Χώρος							
id:2900				Σημεία:5		Εμβαδό:776.83 m ²	
Σημείο	X	Y	μήκος	Σημείο	X	Y	μήκος
T1	478652.542	4218789.972	8.01	T4	478749.657	4218786.424	97.18
T2	478652.372	4218797.984	97.02	T1	478652.542	4218789.972	
T3	478749.324	4218794.442	8.02				

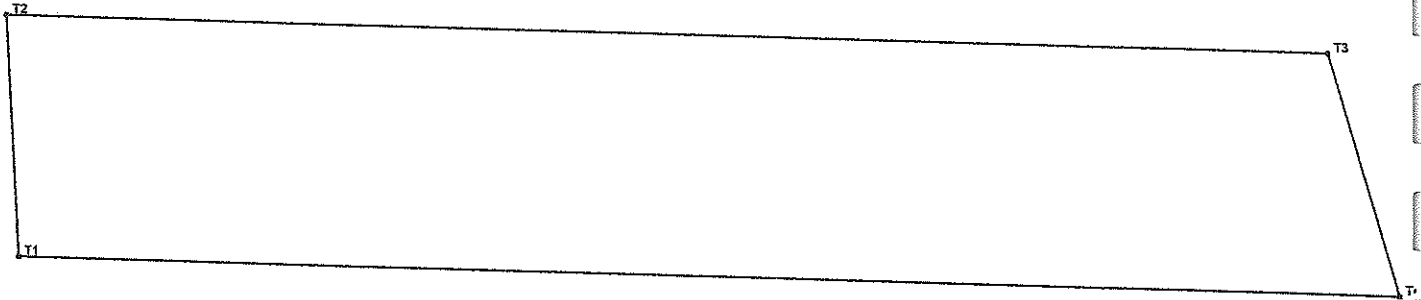

Κοινόχρηστος χώρος							
id:2901				Σημεία:5		Εμβαδό:356.24 m ²	
Σημείο	X	Y	μήκος	Σημείο	X	Y	μήκος
T1	478757.676	4218786.127	8.02	T4	478803.226	4218784.420	45.58
T2	478757.343	4218794.143	43.59	T1	478757.676	4218786.127	
T3	478800.903	4218792.495	8.40				

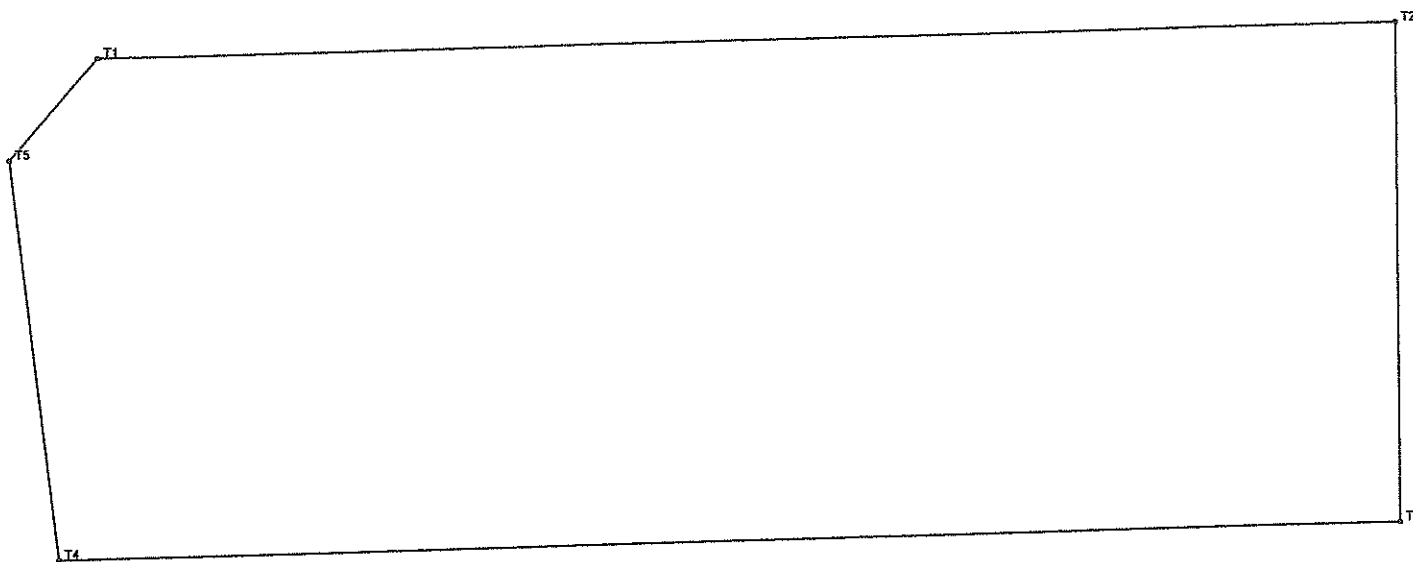

Κοινόχρηστος χώρος							
id:2916		Σημεία:6		Εμβαδό:1079.82 m ²			
Σημείο	X	Y	μήκος	Σημείο	X	Y	μήκος
T1	478494.973	4218574.958	51.64	T4	478493.332	4218554.956	16.05
T2	478546.596	4218576.099		19.96	T5	478491.445	
T3	478546.675	4218556.135	53.36	T1	478494.973	4218574.958	

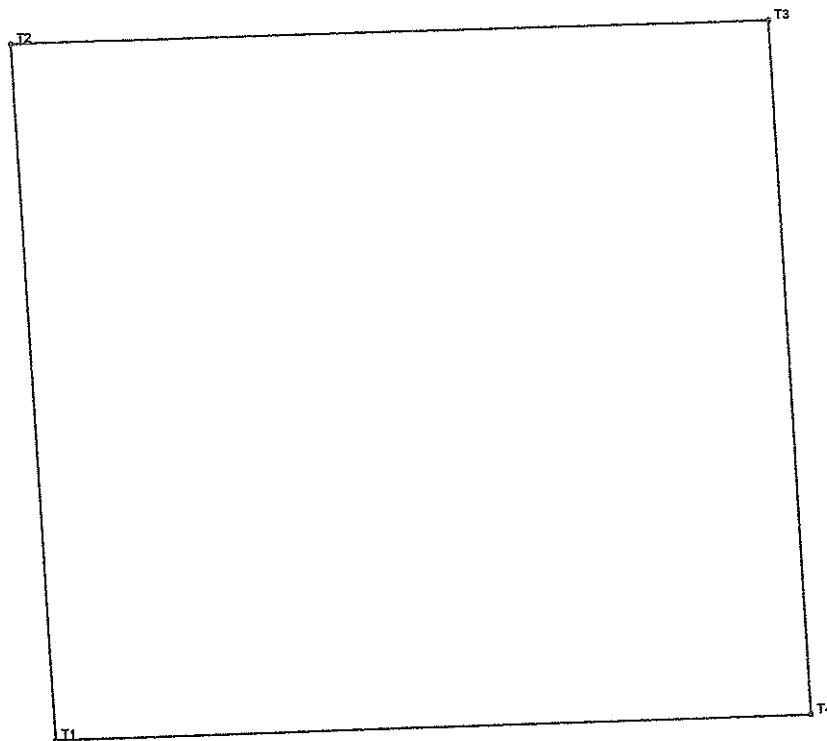

Κοινόχρηστος Χώρος							
id:2929				Σημεία:5		Εμβαδό:854.61 m ²	
Σημείο	X	Y	μήκος	Σημείο	X	Y	μήκος
T1	478633.099	4218371.454	28.15	T4	478663.409	4218372.295	30.32
T2	478631.426	4218399.558	30.44	T1	478633.099	4218371.454	
T3	478661.855	4218400.384	28.13				

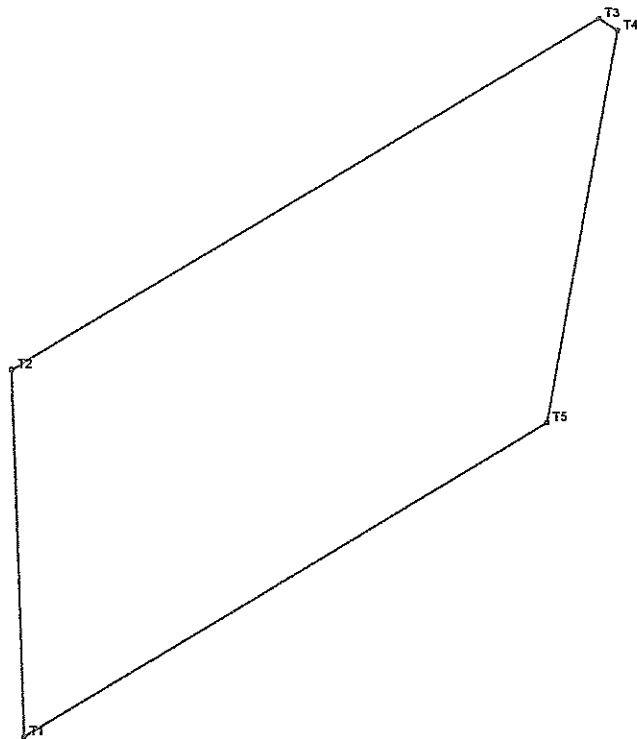

Κοινόχρηστος χώρος							
id:2940		Σημεία:6		Εμβαδό:7636.22 m ²			
Σημείο	X	Y	μήκος	Σημείο	X	Y	μήκος
T1	478671.095	4218044.641	69.91	T4	478783.971	4218178.840	76.01
T2	478669.041	4218114.520	129.85	T5	478770.292	4218104.071	115.64
T3	478780.428	4218181.253	4.29	T1	478671.095	4218044.641	

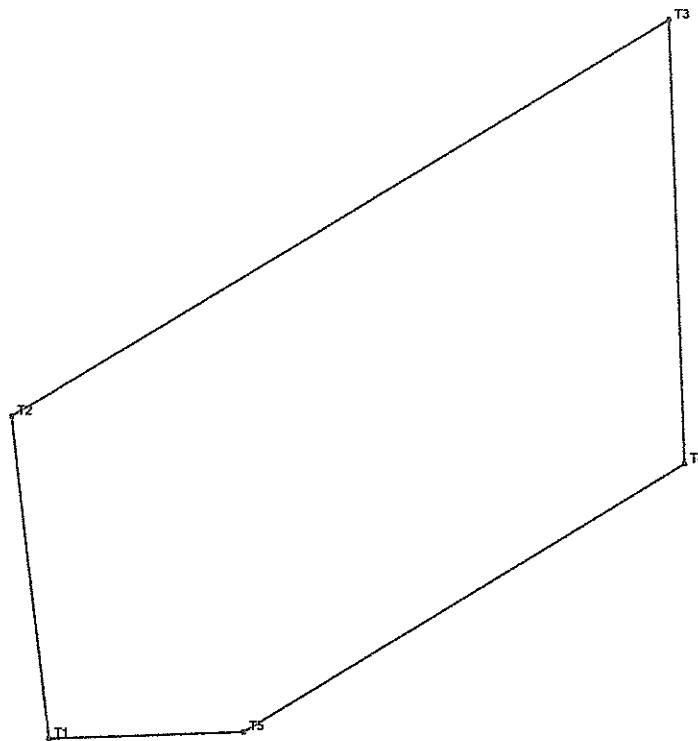

Κοινόχρηστος χώρος							
id:2941		Σημεία:6		Εμβαδό:8083.29 m ²			
Σημείο	X	Y	μήκος	Σημείο	X	Y	μήκος
T1	478555.248	4217994.035	54.96	T4	478663.230	4218039.929	87.63
T2	478549.429	4218048.688	130.07	T5	478588.055	4217994.891	32.82
T3	478661.008	4218115.536	75.64	T1	478555.248	4217994.035	

ΚΟΙΝΩΦΕΛΕΙΣ

ΧΩΡΟΙ

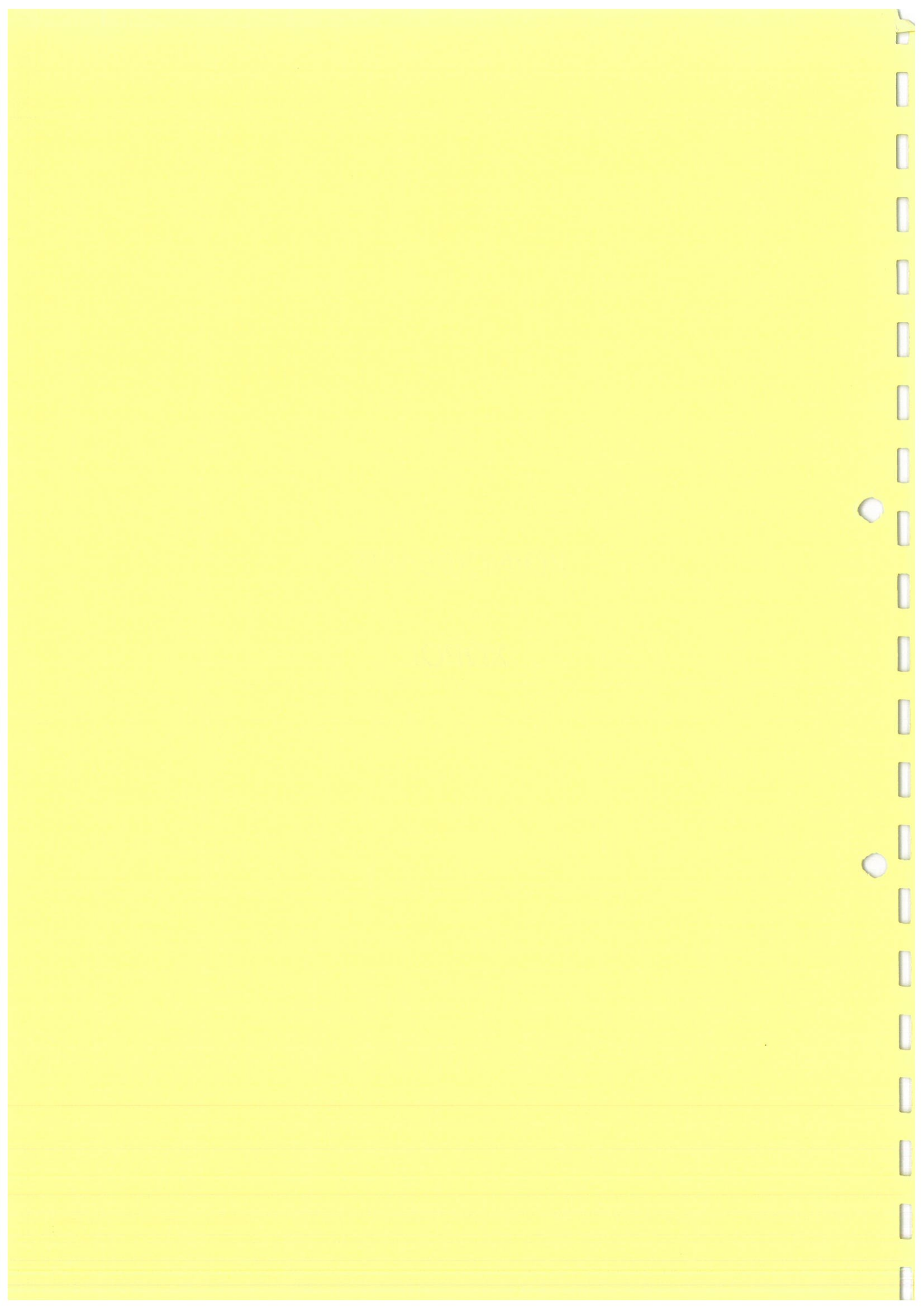

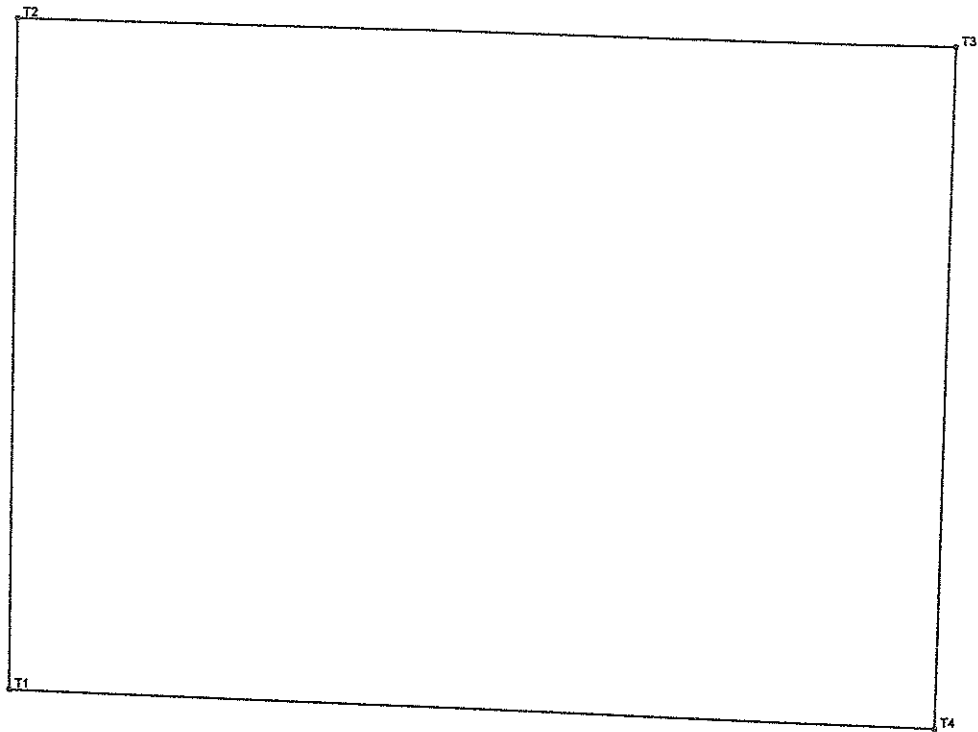

Κοινοφελής χώρος							
id:2714				Σημεία:5		Εμβαδό:849.03 m ²	
Σημείο	X	Y	μήκος	Σημείο	X	Y	μήκος
T1	477603.385	4218533.124	24.67	T4	477637.287	4218531.498	33.94
T2	477603.802	4218557.786		34.38	T1	477603.385	
T3	477638.162	4218556.532	25.05				

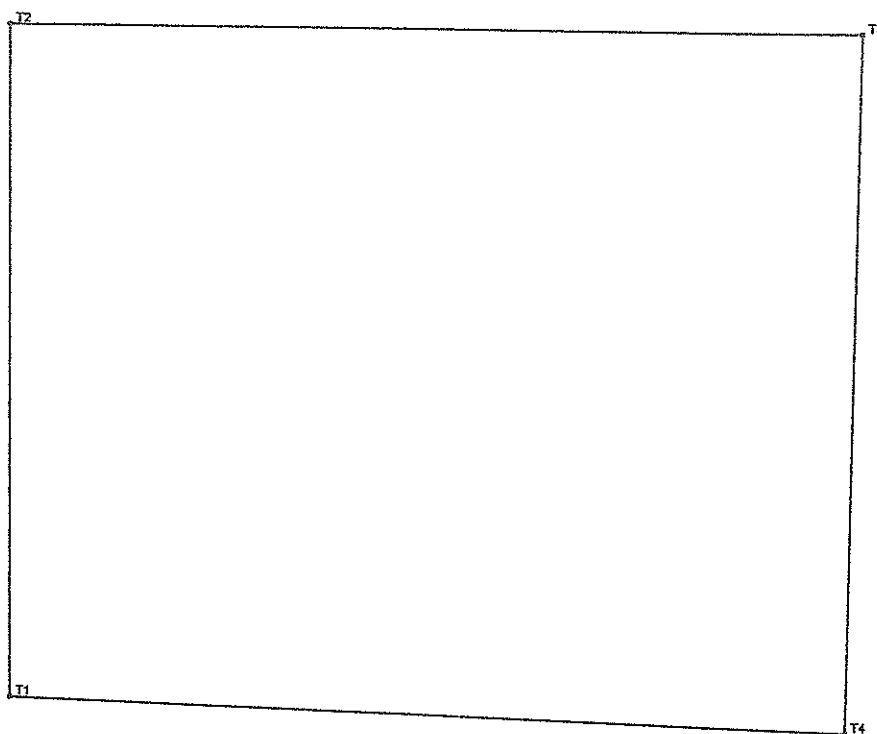

Κοινοφελής χώρος							
id:2726		Σημεία:5		Εμβαδό:4955.16 m ²			
Σημείο	X	Y	μήκος	Σημείο	X	Y	μήκος
T1	477821.648	4218702.619	62.45	T4	477898.666	4218698.574	77.12
T2	477822.144	4218765.066	78.60	T1	477821.648	4218702.619	
T3	477900.727	4218763.414	64.87				

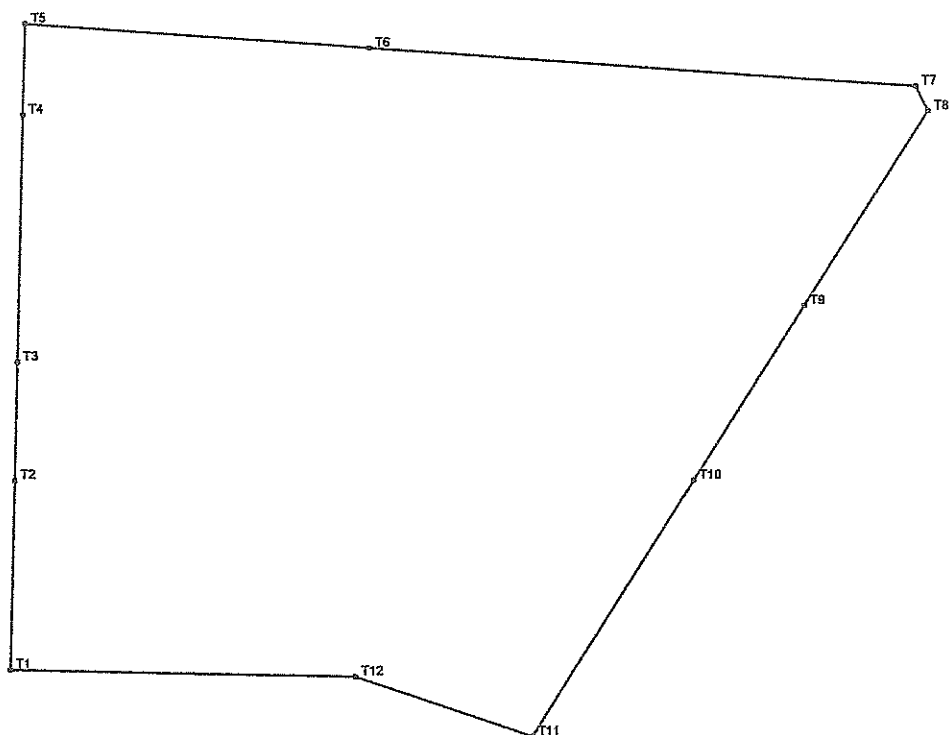

Κοινοφελής χώρος							
id:2766		Σημεία:13		Εμβαδό:8952.39 m ²			
Σημείο	X	Y	μήκος	Σημείο	X	Y	μήκος
T1	477984.548	4218335.566	26.25	T8	478111.102	4218412.234	31.74
T2	477985.229	4218361.807	16.38	T9	478094.044	4218385.464	28.61
T3	477985.654	4218378.183	34.23	T10	478078.687	4218361.320	42.01
T4	477986.543	4218412.397	12.72	T11	478056.143	4218325.874	25.71
T5	477986.873	4218425.112	47.37	T12	478031.841	4218334.261	47.31
T6	478034.105	4218421.463	75.50	T1	477984.548	4218335.566	
T7	478109.382	4218415.647	3.82				

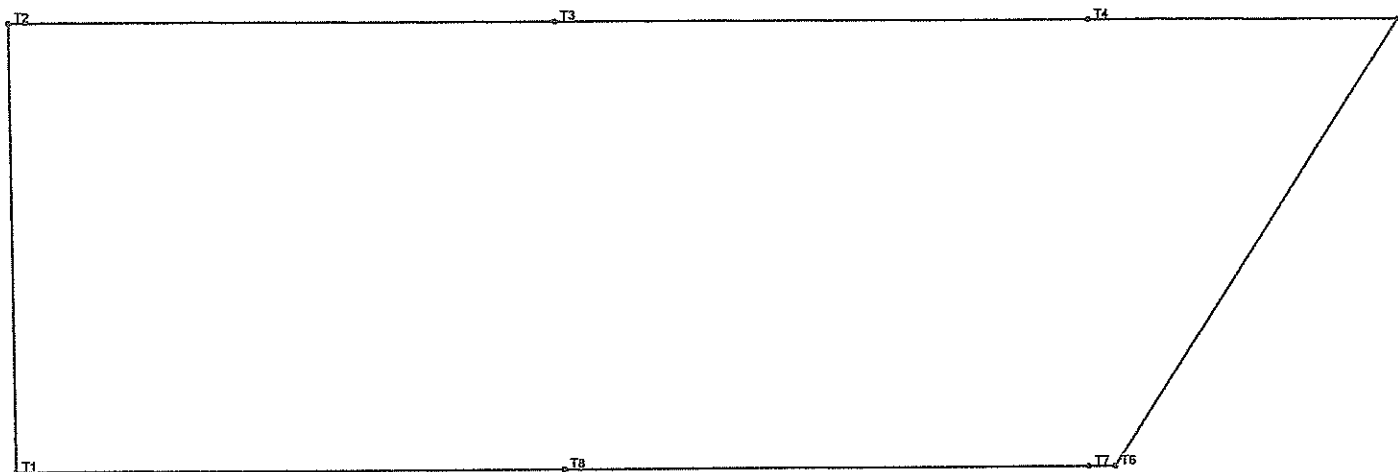

Κοινοφελής χώρος							
id:2779				Σημεία:9		Εμβαδό:6073.00 m ²	
Σημείο	X	Y	μήκος	Σημείο	X	Y	μήκος
T1	477891.179	4218246.798		T6	478005.690	4218246.554	
T2	477890.629	4218293.787	46.99	T7	478002.959	4218246.560	2.73
T3	477947.317	4218293.549	56.69	T8	477948.052	4218246.677	54.91
T4	478003.183	4218293.314	55.87	T1	477891.179	4218246.798	56.87
T5	478035.346	4218293.179	32.16				
			55.26				

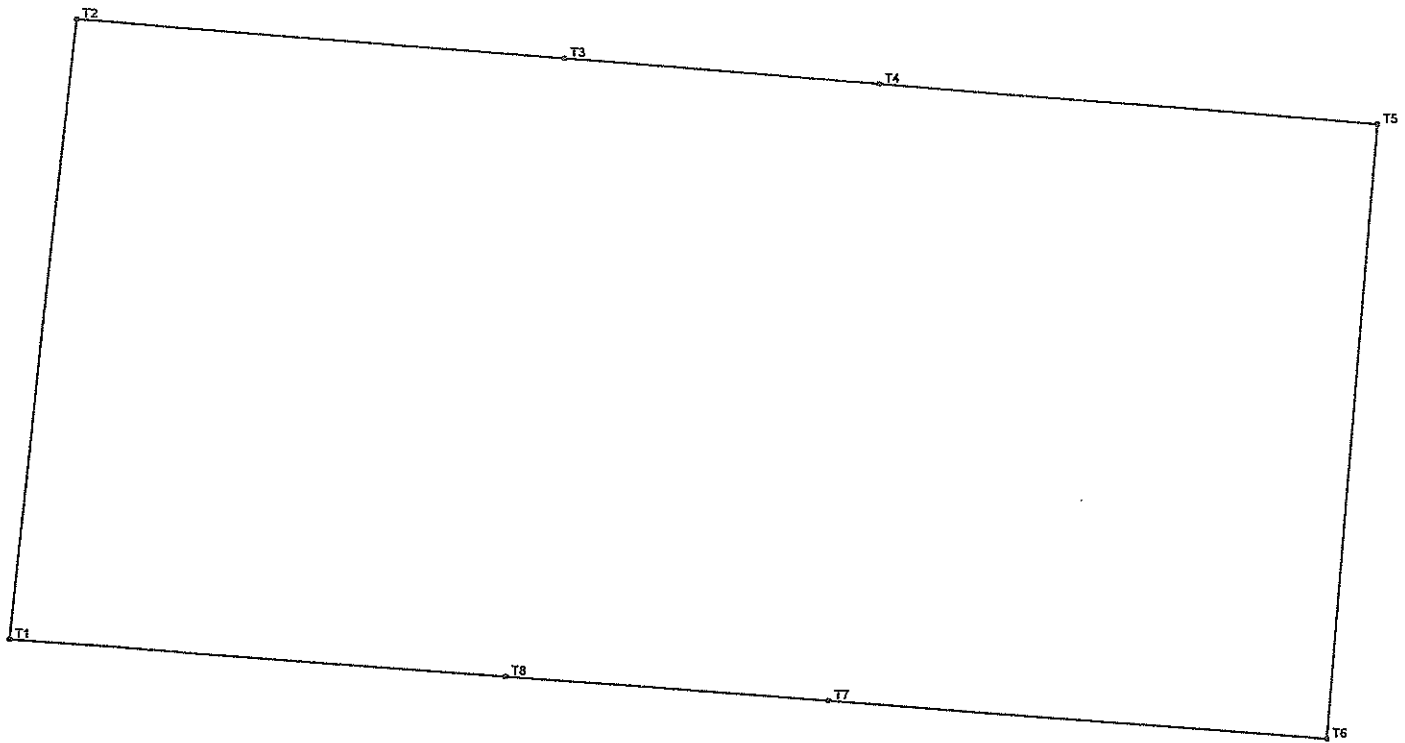

Κοινοφελής χώρος							
id:2795				Σημεία:9		Εμβαδό:4353.49 m ²	
Σημείο	X	Y	μήκος	Σημείο	X	Y	μήκος
T1	477557.543	4218133.764	45.66	T6	477653.731	4218126.791	36.58
T2	477562.144	4218179.188		35.72	T7	477617.242	
T3	477597.755	4218176.422	23.10	T8	477593.660	4218131.146	36.21
T4	477620.784	4218174.633	36.55	T1	477557.543	4218133.764	
T5	477657.227	4218171.802	45.15				

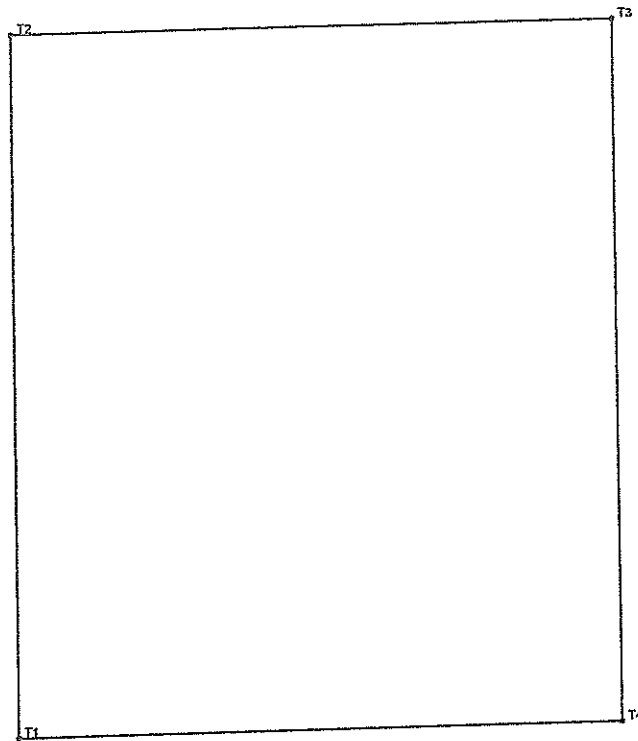

Κοινοφελής χώρος							
id:2871		Σημεία:5		Εμβαδό:1200.47 m ²			
Σημείο	X	Y	μήκος	Σημείο	X	Y	μήκος
T1	478352.572	4218532.987	37.53	T4	478384.600	4218533.695	32.04
T2	478352.393	4218570.517	31.94	T1	478352.572	4218532.987	
T3	478384.321	4218571.234	37.54				

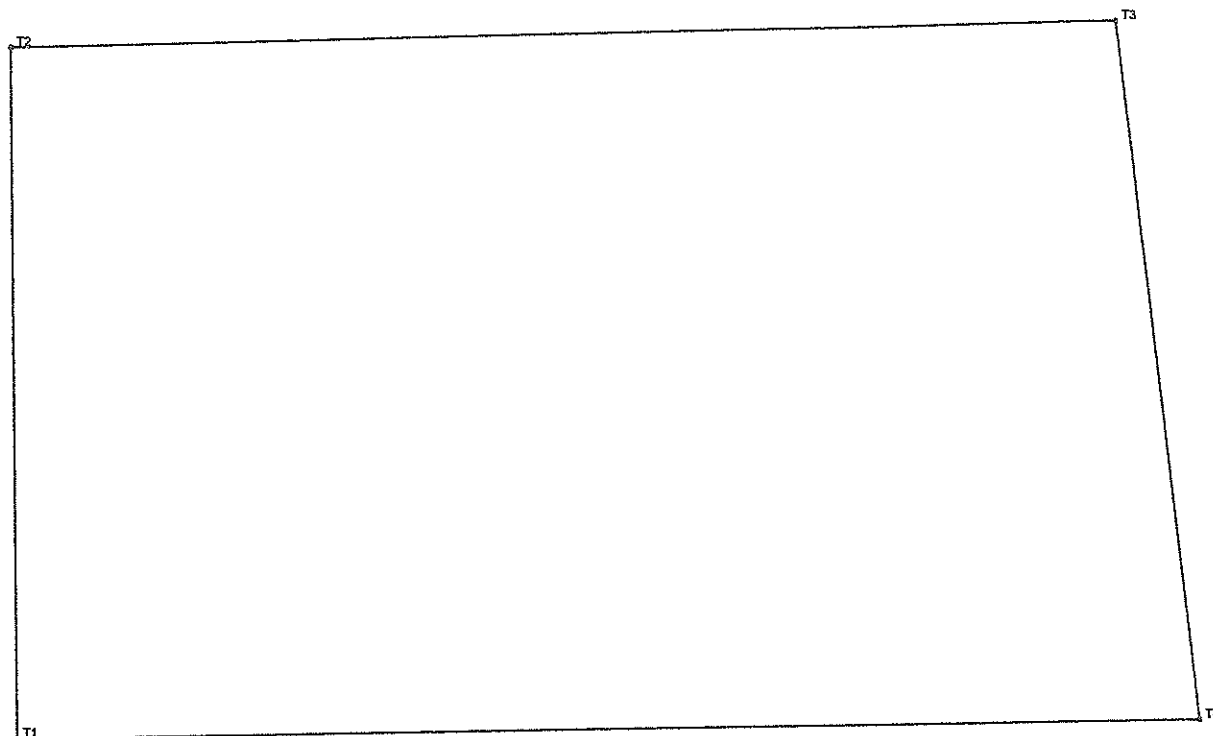

Κοινοφελής χώρος							
id:2872				Σημεία:5		Εμβαδό:4919.20 m ²	
Σημείο	X	Y	μήκος	Σημείο	X	Y	μήκος
T1	478390.725	4218516.991	54.38	T4	478483.579	4218518.255	92.86
T2	478390.320	4218571.369	86.76	T1	478390.725	4218516.991	
T3	478477.061	4218573.316	55.45				

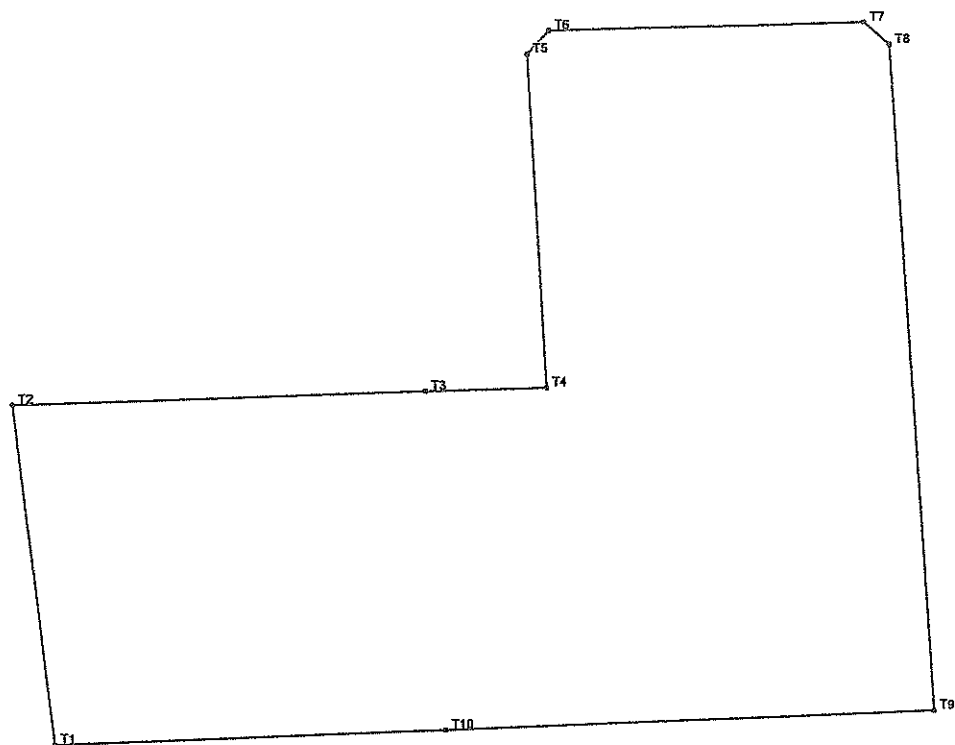

Κοινοφελής χώρος							
id:2924				Σημεία:11		Εμβαδό:7108.39 m ²	
Σημείο	X	Y	μήκος	Σημείο	X	Y	μήκος
T1	478513.462	4218384.908	44.14	T7	478617.783	4218477.306	4.33
T2	478508.273	4218428.739	52.81	T8	478620.961	4218474.370	86.17
T3	478561.063	4218430.014	15.57	T9	478626.083	4218388.349	62.79
T4	478576.632	4218430.391	43.13	T10	478563.326	4218386.432	49.89
T5	478574.396	4218473.458	4.17	T11	478513.462	4218384.908	
T6	478577.240	4218476.513	40.55				

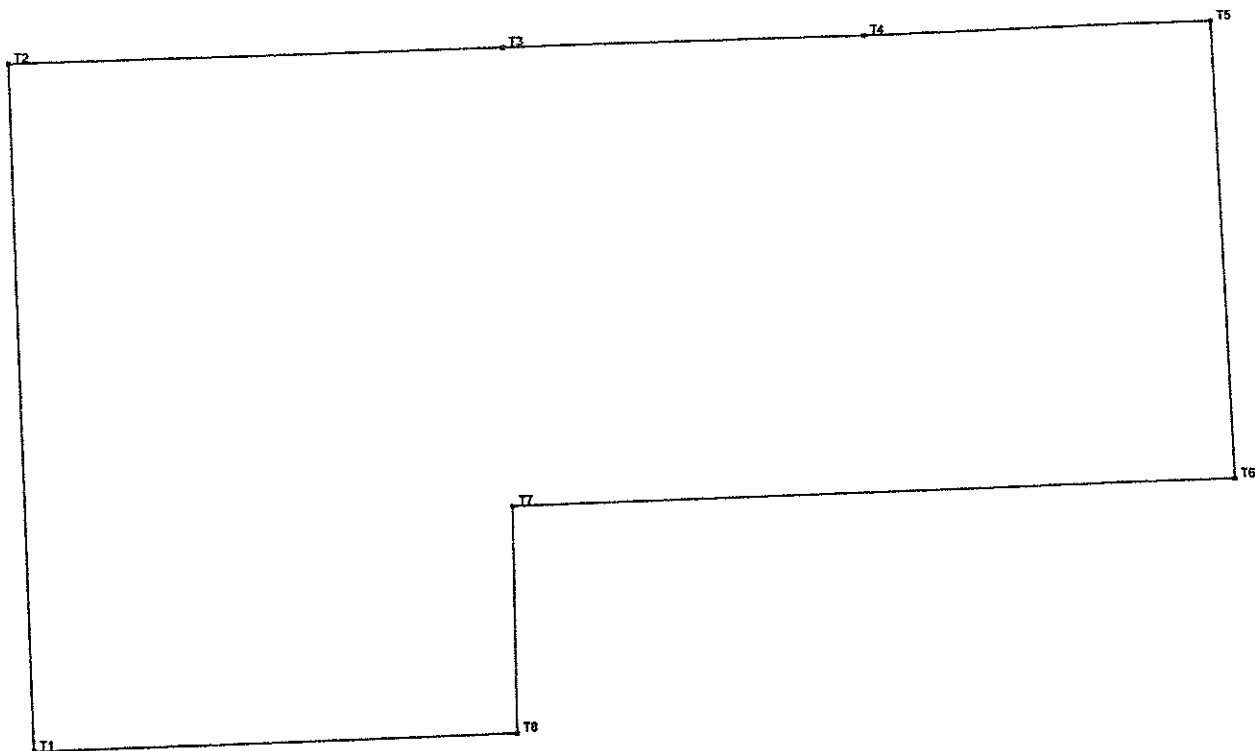

ΚΟΙΝΩΦΕΛΗΣ ΧΩΡΟΣ							
id:2933				Σημεία:9		Εμβαδό:5460.08 m ²	
Σημείο	X	Y	μήκος	Σημείο	X	Y	μήκος
T1	478605.807	4218250.924	62.47	T6	478714.995	4218274.099	65.66
T2	478604.421	4218313.380	44.69	T7	478649.355	4218272.559	20.59
T3	478649.106	4218314.237	32.85	T8	478649.478	4218251.968	43.68
T4	478681.952	4218314.867	31.42	T1	478605.807	4218250.924	
T5	478713.360	4218315.832	41.77				

